

VACUUM GAUGE

DVR 3pro  II 2 G Ex ib IIC T4 Gb



Instructions for use



**Original instructions
Keep for further use!**

This manual is only to be used and distributed in its complete and original form. It is strictly the user's responsibility to carefully check the validity of this manual with respect to the product.

Manufacturer:

VACUUBRAND GMBH + CO KG
Alfred-Zippe-Str. 4
97877 Wertheim
GERMANY

Phone:

Head office +49 9342 808-0
Sales +49 9342 808-5550
Service +49 9342 808-5660

Fax: +49 9342 808-5555

Email: info@vacuubrand.com

Web: www.vacuubrand.com

*Thank you for purchasing this product from **VACUUBRAND GMBH + CO KG**. You have chosen a modern and technically high quality product.*

TABLE OF CONTENT

What's in the box	4
1 Introduction	5
1.1 User information	5
1.2 About this document	6
1.2.1 Display conventions	6
1.2.2 Symbols and icons	7
1.2.3 Handling instructions (action steps)	8
1.2.4 Abbreviations	9
1.2.5 Term definition	9
2 Safety instructions	10
2.1 Usage	10
2.1.1 Intended use	10
2.1.2 Improper use	10
2.1.3 Foreseeable misuse	11
2.2 General safety instructions	12
2.2.1 Safety precautions	12
2.2.2 Personnel	12
2.3 Correct battery handling	13
2.4 Proper disposal	13
3 Product description	14
3.1 Vacuum gauge DVR 3pro	15
3.2 Various views	15
3.3 Application example	17
4 Assembly and connection	18
4.1 Installation conditions	18
4.2 Insert (replace) battery	19
4.3 Vacuum connection	20
5 Operation	23
5.1 Operating and display elements	23
5.1.1 Operating elements	23
5.1.2 Key combinations	24
5.1.3 Automatic jump-back times	24
5.1.4 Display elements	25
5.1.5 Display icons	26

5.2	DVR 3pro handling	27
5.2.1	Select pressure unit	27
5.2.2	Adjust switch on time and measuring cycle	28
5.2.3	Pressure measurement.	30
6	Cleaning and adjustment	31
6.1	Cleaning	31
6.1.1	Housing surface	31
6.1.2	Sensor	31
6.2	Sensor adjustment, in general	32
6.2.1	Adjustment at atmospheric pressure.	32
6.2.2	Adjustment to reference pressure.	34
6.2.3	Adjustment under vacuum	36
7	Resolving problems	38
7.1	Error display	38
7.2	Fault – Cause – Remedy	39
8	Appendix	40
8.1	Technical information	40
8.1.1	Technical data.	40
8.1.2	Wetted materials.	41
8.1.3	Device data.	42
8.2	Ordering information.	43
8.3	Service.	44
8.4	Index.	45
8.5	EC Declaration of Conformity.	46
8.6	Declaration of Conformity – China RoHS 2	48

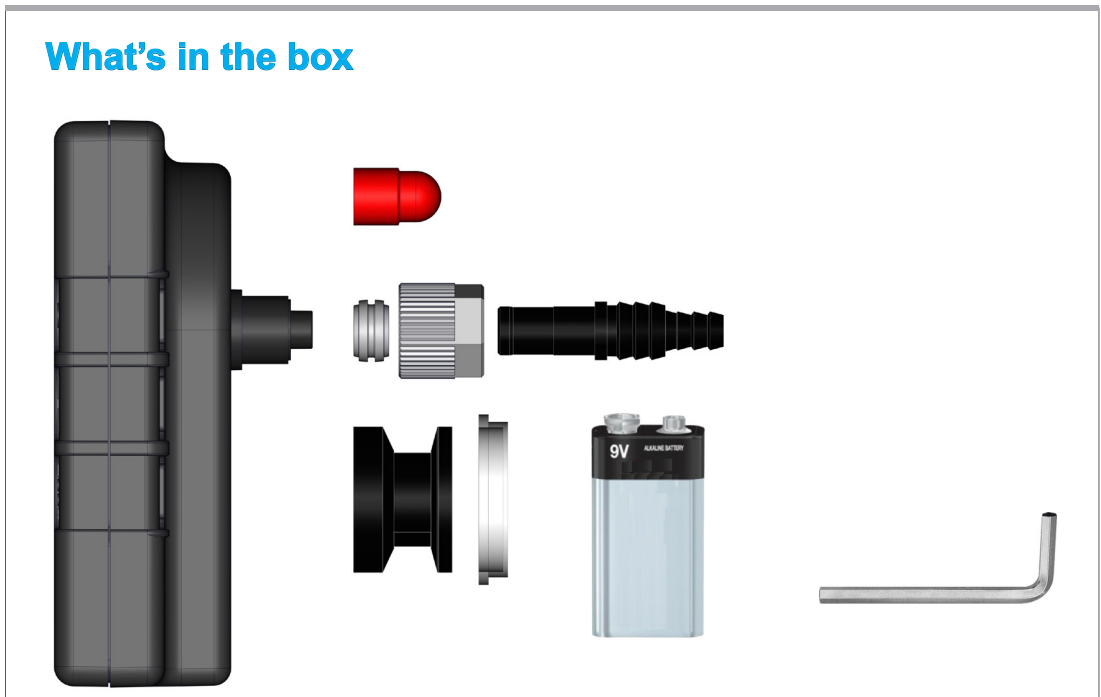

1 Introduction

This manual is part of your product.

1.1 User information

Safety

Instructions for use
and safety

- Read this manual thoroughly and completely before using the product.
- Keep this manual in an easily accessible location.
- Proper use of the product is essential for safe operation. Comply with all safety instructions provided!
- In addition to this manual, adhere to any relevant local accident prevention regulations and comply with industrial safety regulations.

General

General
information

- Instead of the term **DVR 3pro** mostly the term **Gauge** or **Vacuum gauge** is used in this manual, in order to make the text more readable.
- The illustrations in this manual are provided as examples in order for a better understanding.
- They are intended to aid in your understanding of the proper use of the product.

Contact

Contact us

- Please ask for replacement in case of an incomplete manual or download the manual on our website: www.vacuubrand.com
- Contact us regarding any questions about this product, if you need further information, or to provide us with feedback.
- When contacting our Customer Service Department, please be sure to have the correct type and serial number of your product at call → *device data on the product, see chapter 8.1.3 Device data on page 42*

Copyright

Copyright © The content of this manual is protected by copyright. Only copies for internal use are allowed, e. g., for professional training.



© VACUUBRAND GMBH + CO KG

1.2 About this document

1.2.1 Display conventions

Warning levels

Warning levels

	<p>DANGER</p> <p>Indicates an imminent hazardous situation. Disregarding the situation will result in serious and even fatal injury or death.</p> <p>⇒ Take appropriate action to avoid dangerous situation!</p>
	<p>WARNING</p> <p>Indicates a potentially hazardous situation. Disregarding the situation could result in serious, even fatal injury or massive damage to property.</p> <p>⇒ Take appropriate action to avoid dangerous situation!</p>
	<p>CAUTION</p> <p>Indicates a potentially hazardous situation. Disregarding the situation could result in slight or minor injury or damage to property.</p> <p>⇒ Take appropriate action to avoid dangerous situation!</p>
<p>NOTICE</p> <p>Notice for a potentially harmful situation. Disregarding the notice could lead to material damage.</p>	

Additional notes

IMPORTANT!

⇒ Information or specific use recommendation, which must be observed.

⇒ Important information for proper operation.



⇒ Helpful tips and tricks

⇒ Additional information

1.2.2 Symbols and icons

This manual includes symbols and icons. Safety symbols indicate special danger in handling the product. Icons shall help to identify the danger directly and easier.

Safety symbols



General warning symbol.



danger: electricity













General prohibition symbol.



General mandatory sign.

Additional icons

Notes		Positive example – Do! Result – o. k.		Negative example – Do not!
		Refers to content in this manual.		Refers to content of other supplementary doc- uments.
			Electric/electronic devices and batteries must not be disposed of in the domestic waste at the end of their service life.	
Handling or action		Press key.		Push and hold key
	Signals		Continuous signal	



⇒ For further detailed information about icons and signals in the display see chapter *Display icons on page 26*.

1.2.3 Handling instructions (action steps)

Presentation
convention operating
steps

Action step (single step)

⇒ Do the described step.

Result of action

Handling instructions (multiple steps)

1. first step

2. next step

Result of action

Follow steps in the described order.

1.2.4 Abbreviations

Used
Abbreviations

abs.	absolute
ATM	Atmospheric pressure
d_i (di)	Interior diameter
DAkkS	Deutsche Akkreditierungsstelle GmbH (accreditation institute)
DN	Nominal diameter
El. Data	Electrical data
	ATEX equipment labeling
GF	Glass fiber reinforced
GK	Glass pellets
Gr.	Size
hPa	Pressure unit, Hectopascal (1 hPa = 1 mbar = 0.75 Torr)
KF	Small flange
max	Maximum value
mbar	Pressure unit, millibar (1 mbar = 1 hPa = 0.75 Torr)
min	Minimum value
PA	Polyamide
PBT	Polybutylene terephthalate
PP	Polypropylene
PPS	Polyphenylene sulphide
PTFE	Polytetrafluorethylene
RMA-N°	Return Merchandise Authorization number
Sec.	Second(s)
Torr	Pressure unit (1 Torr = 1.33 mbar = 1.33 hPa)

1.2.5 Term definition

Product specific
terms

DVR 2pro	Fully electronic vacuum gauge for measurement within the measuring range of atmospheric pressure and 1 mbar, with digital and analogue pressure reading.
DVR 3pro	Functions like DVR 2pro, including ATEX approval
Rough vacuum	Pressure measuring range in vacuum technology, from: atmospheric pressure–1 mbar (atmospheric pressure–0.75 Torr)

2 Safety instructions

The complete information of this chapter must be observed by all persons working with the herein described product. The safety instructions are valid for the complete life cycle of the product.

2.1 Usage

Use the product only when it is in proper working condition.

2.1.1 Intended use

Intended use

A vacuum gauge **DVR 3pro** is a laboratory instrument for the measurement of absolute pressure in the range of rough vacuum and intended for connection to a vacuum apparatus. The gauge is intended for continuous operation and certified for the use in explosion-hazardous areas of zone 1 and zone 2.

Any other use is considered to be improper use.

Intended use also includes the following:



- observing safety information of document **Safety Information for Vacuum Equipment**.
- observing the safety information inside this manual

2.1.2 Improper use

Incorrect use or any application which does not correspond to the technical data may result in injury or damage to the property.

Improper use includes:

Improper use

- Using the product contrary to its intended use.
- Operation despite obvious malfunctions or damages.

- Improper use
- Operation at inadmissible operating conditions.
 - inadmissible modifications or repairs by customer.

IMPORTANT!

The penetration of foreign objects, hot gases and flames from the application must be excluded.

2.1.3 Foreseeable misuse

Foreseeable misuse



- The measuring of media which are liquid, hot, instable or explosive.
- Installation and operation in an explosive environment, which does not approve to the specified zone.
- to switch the gauge on/off with tools,
- the battery installation or replacement in an explosive area,
- to use a tool for battery replacement, which could cause a short circuit,
- to expose the gauge completely to vacuum,
- to operate the controller with sharp stylus or objects.
- to immerse the gauge into liquid or to clean it with steam.

2.2 General safety instructions

2.2.1 Safety precautions

- Safety precautions
- ⇒ Use the gauge only if you have understood its function and this manual.
 - ⇒ Please note that adhering process media can pose danger to humans and the environment.
 - ⇒ When handling with contaminated parts, follow the relevant regulations and safety precautions.
 - ⇒ Repairs are only allowed by the Service Department or your local supplier.

IMPORTANT! For all service works hazardous substances need to be excluded.

- ⇒ Fill in the form [Health and Safety Clearance](#) thoroughly and completely and confirm with your signature.
-

2.2.2 Personnel

IMPORTANT! It is the owner's responsibility to observe the proper use of the device.

- ⇒ Always be conscious of safety, and work in a safe manner.
- ⇒ Observe the owners' directives at work, the national accident prevention regulations and occupational safety provisions.

2.3 Correct battery handling

Correct battery
handling



CAUTION

Risk of personal injury or damage to property if batteries are used improperly.

- ⇒ Do not short-circuit the battery or touch both poles at the same time.
- ⇒ Never charge the battery (= non-rechargeable).
- ⇒ Never use damaged batteries.
- ⇒ Do not expose the battery to high temperatures.
- ⇒ If the battery leaks and you come into contact with the leaked fluids, rinse thoroughly with water and seek medical attention immediately!

2.4 Proper disposal

NOTE

Electronic components and batteries must not be disposed of in the domestic waste at the end of their service life.

Used electronic devices and batteries contain harmful substances that can cause damage to the environment or human health. Disused electrical devices also contain valuable raw materials, which can be recovered for reuse if the device is disposed of correctly within the recycling process.

End users are legally obliged to take used electric and electronic devices to a licensed collection point and to return spent batteries.

- ⇒ It is your responsibility to save and delete any data before disposing of your electronic device.
- ⇒ If the device contains batteries: Remove spent batteries before disposal.
- ⇒ Correctly dispose of all electronic scrap and electric components at the end of their service life.
- ⇒ Observe the national regulations regarding disposal and environmental protection.



3 Product description

Goods arrival

Goods arrival Check the shipment for transport damage and completeness.
⇒ Report any transit damage immediately to the supplier.

NOTICE

Condensate could damage the gauge.

A large difference in temperature between storage location and installation location can cause condensation.

⇒ Let the product acclimatize for 3-4 hours before using it.

Included materials

Included materials

Gauge	
DVR 3pro	20682907
Union nut M14x1 (union nut)	20637657
Hose nozzle D6/10	20636635
Locking ring for knurled nut	20637658
Small flange KF 16 PP	20635110
Protective cap DN 10/16	
O-ring	
9 V Block-type battery, enclosed	20612891
Hex key, size 2	20635062
Instructions for use	20901134
Original packaging	-----

3.1 Vacuum gauge DVR 3pro

Gauge description

DVR 3pro is a fully electronic battery operated vacuum gauge for measurement¹ within the measuring range of atmospheric pressure and 1 mbar.

The **DVR 3pro** has an integrated ceramic diaphragm vacuum sensor and is exceptionally resistant to chemicals.

The gauge has a large LC-display for analog and digital pressure reading. The pressure unit is selectable between mbar, hPa or Torr.

The **DVR 3pro** is operated by keys placed on the rear.

3.2 Various views

Front and side view

Front and side view

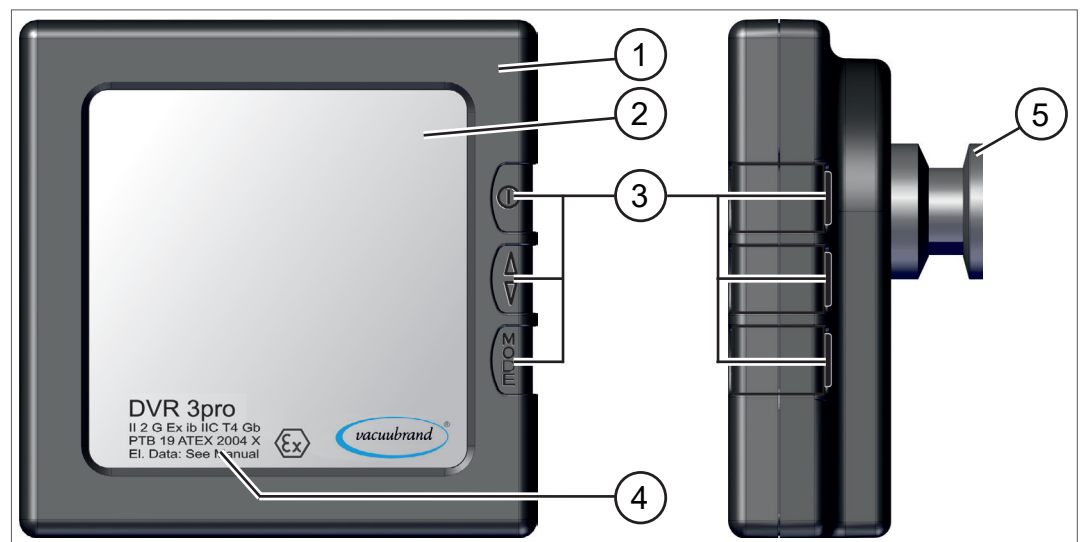

Meaning

1	Chemically resistant, conductive plastic housing
2	LC display (LCD)
3	Operating keys
4	Device name + ATEX specification*
5	Vacuum screw connection

* Group and category, marking G (gas), type protection, explosion group, temperature class (additionally see: [Approval for ATEX equipment](#)).

¹ Absolute pressure measurement

Rear side

Rear view

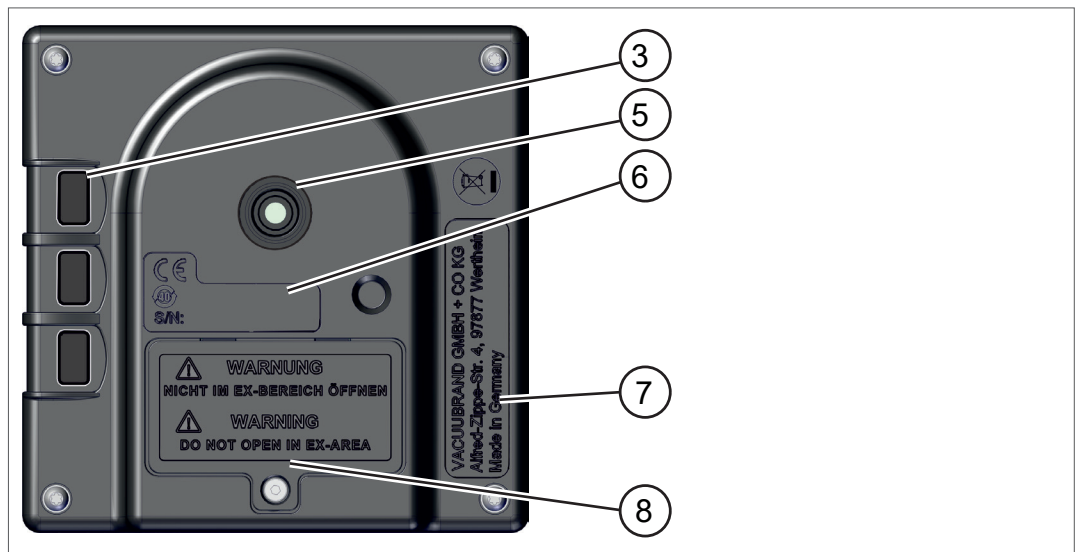

Meaning

3 Operating keys**5 Vacuum screw connection, support for**

- ▶ Hose nozzle with locking ring and knurled nut
or
- ▶ Hose directly connected with locking ring and knurled nut
or
- ▶ Small flange KF 16

6 Serial number + CE symbol**7 Manufacturer + address (rating plate)****8 Battery compartment lid with hexagon socket screw (captive screw)**

- ▶ Block-type battery 9 V

3.3 Application example

→ Example
DVR 3pro with dryer

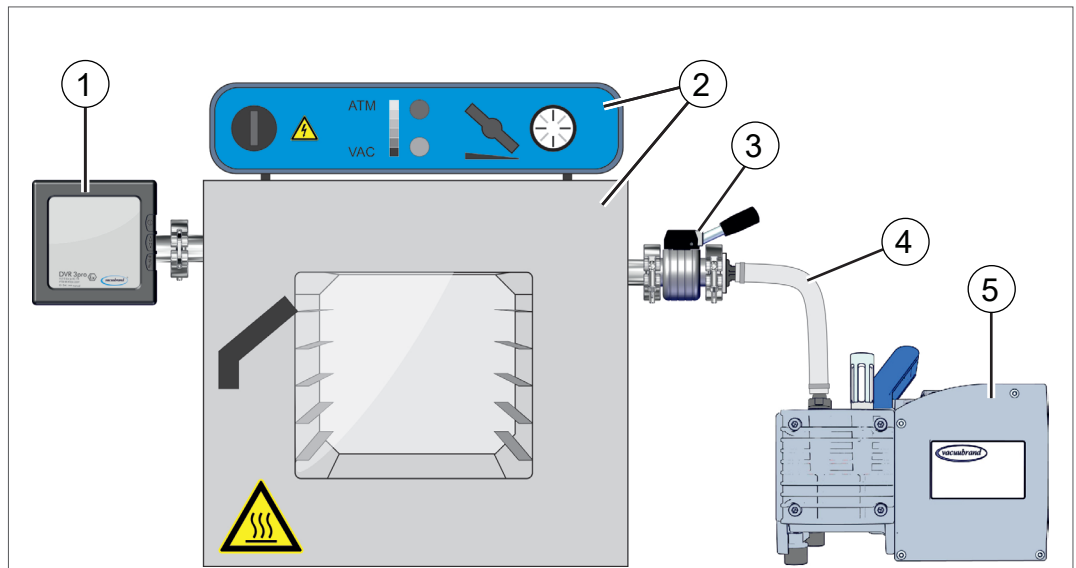

Meaning

- | | |
|---|---|
| 1 | DVR 3pro, directly flange-mounted |
| 2 | Cabinet dryer with Ex-zone inside the dryer |
| 3 | Valve |
| 4 | Vacuum hose |
| 5 | Diaphragm pump, vacuum pump |



Please observe the following points to get an optimal measuring result:

- ⇒ Connect the gauge as close as possible to the apparatus, not to the vacuum pump.
- ⇒ If possible use the small flange for connection.
- ⇒ Connect the vacuum line as short as possible with a cross-section as wide as possible.

4 Assembly and connection

The gauge is provided to be used directly at the application.

- ⇒ Observe all specifications for installation, connection and operation according to technical data, → see *chapter Technical information on page 40*.
- ⇒ Also observe rating plate data.
- ⇒ Compare the permitted limits which are described in this manual, with your actual application regarding operating media, pressures, forces, moments, temperatures and voltage.

NOTICE

Permanent vibrations which are transmitted from the apparatus to the gauge could loosen screw connections.

- ⇒ Mount the gauge to a vibration-free apparatus.
- ⇒ Please use buffers, if constant vibration is unavoidable.

4.1 Installation conditions

Consider installation conditions

- The gauge has acclimatized.
- Ambient conditions are observed and are within the limitation of use.

Observe limitation of use

Limitation of use	
Ambient temperature	10–40 °C
Altitude, max.	3000 m above sea level
Relative humidity	30–85 %, non condensing
Protection type	IP 40
Avoid condensation or contamination by dust or liquids.	

4.2 Insert (replace) battery

Insert battery

The battery is enclosed to the delivery and must be inserted into the gauge before installation. **Approved batteries** → see *chapter 8.2 Ordering information on page 43*



DANGER

Risk of explosion during battery installation in an explosive environment.

If the battery will be replaced in an explosion-risk zone, ignition sparks could lead to an explosion.

- ⇒ Battery installation or replacement only allowed in an Ex-free zone.
- ⇒ Ensure that the self-adhesive insulating foil is placed properly between housing and battery contacts.

Insert (replace) battery

Required tool Allen key, size 2.

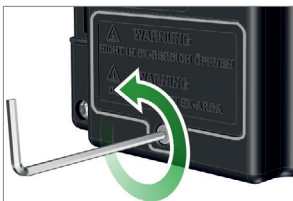

1. Use a Phillips screwdriver to unscrew the screw of the battery compartment lid.

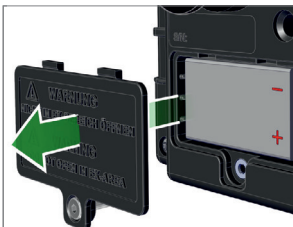

2. Remove battery compartment lid with captive screw. When changing the battery, please remove the discharged battery.

IMPORTANT! Tools for battery replacement must not cause a short-circuit.

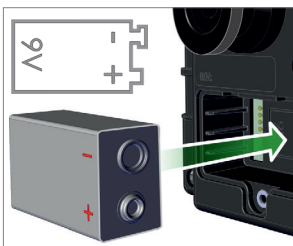

3. Put in the new battery in correct position (compare to figure inside the housing).

IMPORTANT! Please ensure that the insulating foil between housing and battery contacts is placed properly.



4. Put the battery compartment lid in correct position onto the gauge and fix it stress-free by the captive screw. When tightening, observe the maximum torque of 0.4 Nm.

4.3 Vacuum connection

	WARNING
	<p>Risk of bursting</p> <p>⇒ Prevent uncontrolled overpressure, e. g., when connecting to a locked or blocked tubing system.</p>

IMPORTANT!

- ⇒ Maximum admissible pressure at vacuum sensor: 1,5 bar/1126 Torr (abs.).
- ⇒ Pollution and damages, especially at the flange, could affect the measurement.

Connection options

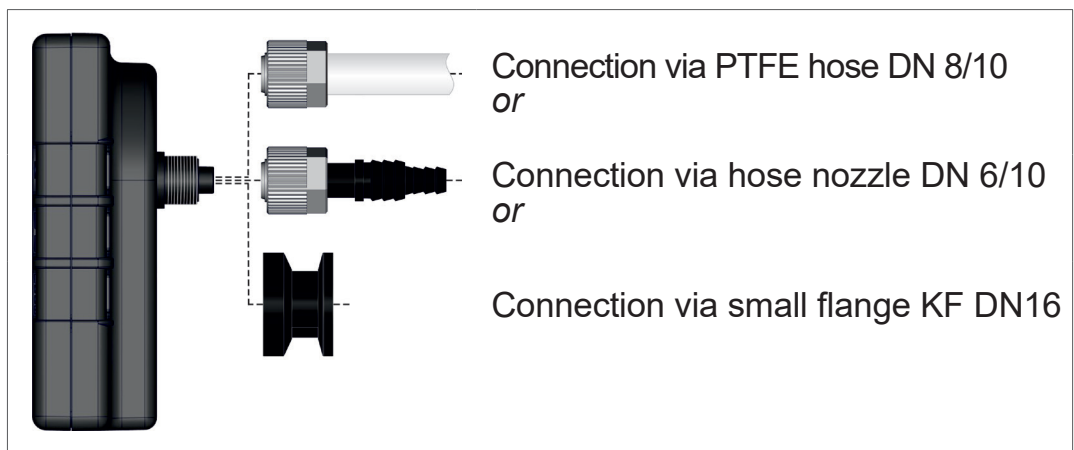

Connection via hose nozzle

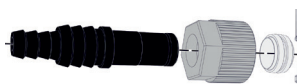

Required connection material: Hose nozzle DN 6/10 mm, union nut M14x1, locking ring; optionally: Vacuum hose and compatible hose clamp (tool: fork wrench size 17).



1. If installed, unscrew the small flange from the vacuum connection of the gauge.

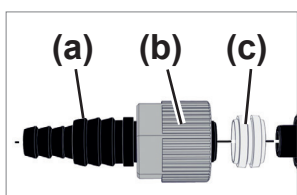

2. Connect hose nozzle (a), union nut (b) and locking ring (c) as shown in figure.

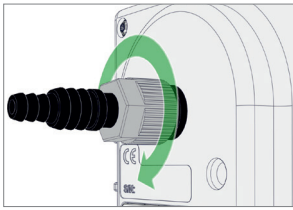

3. Push the PTFE-hose into the vacuum connection connection of the gauge and fasten it with the union nut.

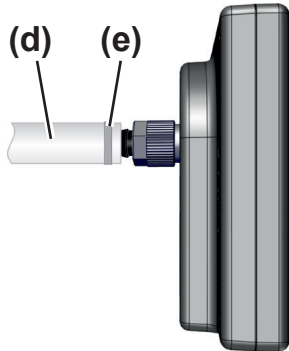

4. Push the vacuum hose **(d)** of the apparatus onto the hose nozzle and fasten the hose, e. g., with a hose clamp **(e)**.
5. Fix the vacuum gauge close to your apparatus, e. g., to a stand system.

Connection via PTFE hose

Required connection material: Union nut M14x1, locking ring; optionally: PTFE Hose DN 8/10.

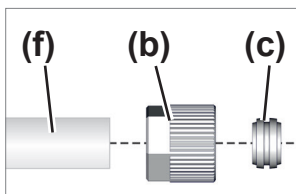

1. If installed, unscrew the small flange from the vacuum connection of the gauge.

2. Connect locking ring **(b)**, union nut **(c)** and PTFE hose **(f)** as shown in figure.

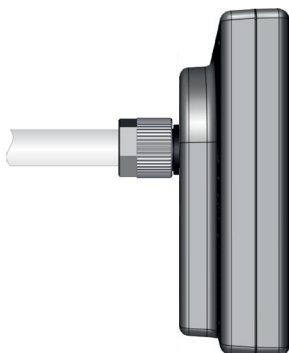

3. Push the PTFE-hose into the vacuum connection connection of the gauge and fasten it with the union nut.

PTFE Hose fixed.

IMPORTANT!

- ⇒ Use a stable vacuum hose that is suitable for the required vacuum range.
- ⇒ Connect hose tubes as short as possible.

Connection via small flange

Required connection material: Clamping ring with centering or centering ring for KF DN16 (tool: fork wrench size 17).

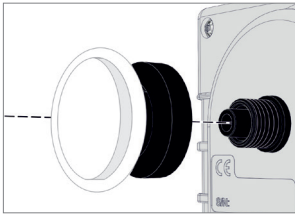

1. Place the small flange KF DN16 on top of vacuum connection of the gauge.



2. Screw in the small flange KF DN16 hand tight.

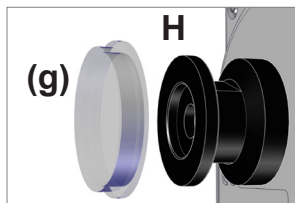

3. Remove the protection cap **(g)** from the small flange KF DN16 **(h)**.

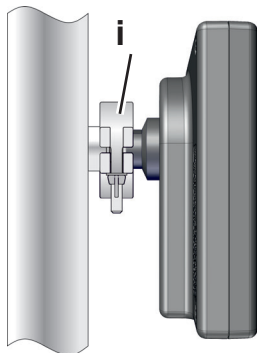

4. Put the gauge with the centering onto the connection of the apparatus → small flange KF DN16.
5. Fix the vacuum gauge with a clamping ring **(i)**.

NOTICE

⇒ If necessary, measure the leakage rate (integral leakage rate < 0.1 mbar l/s) after installation or replacement of the connection components.

5 Operation

5.1 Operating and display elements

5.1.1 Operating elements

The operation keys are on the rear. They correspond to the respective symbol on the front frame.

Operating elements

Operating elements
DVR 3pro

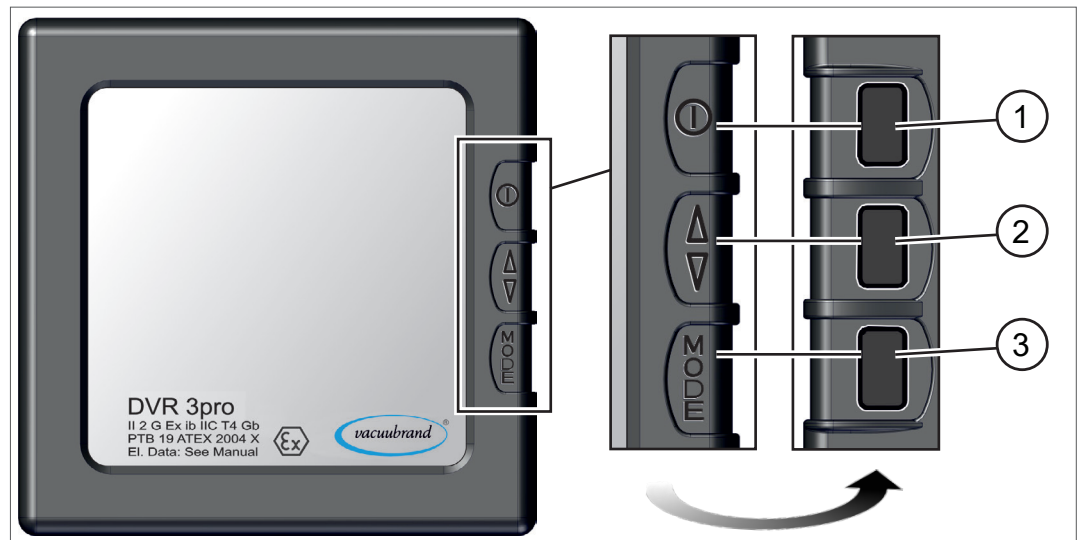

Key function

N°	Key	Meaning
1		ON/OFF <ul style="list-style-type: none"> ▶ Switch on/off gauge ▶ Confirm pressure unit ▶ Quit mode
2		UP/DOWN <ul style="list-style-type: none"> ▶ With pointer direction: left = decrease value, right = increase value ▶ Select pressure unit ▶ Adjust display power-on time
3		MODE <ul style="list-style-type: none"> ▶ Call-up power-on time menu ▶ Adjust measurement frequency ▶ Change pointer direction
1-3	all	<ul style="list-style-type: none"> ▶ Only when clock is displayed: Reset automatic switch-off

5.1.2 Key combinations





Certain functions, such as selecting the pressure unit and calling up the adjustment mode, can only be called up via key combinations. For that the gauge needs to be switched off.

NOTICE

Wrong key combinations can lead to faulty settings.

⇒ First push and hold the key which must be hold and pressed, only then push the combination key shortly.

Key combination

Combination	Meaning
 + 	<p><i>Press and hold MODE + press ON/OFF =</i></p> <ul style="list-style-type: none"> ▶ Display of the adjusted Pressure unit.
 + 	<p><i>Press and hold UP/DOWN + Press ON/OFF =</i></p> <ul style="list-style-type: none"> ▶ Call-up adjustment mode

5.1.3 Automatic jump-back times

Without any action, the display switches automatically back to pressure display – settings will not be stored.

Jump-back times

From menu	Jump-back time (Sec.)
Power-on time	20
Measuring cycle	20
Unit (pressure unit)	20
Adjustment mode	20

5.1.4 Display elements

Directly after switching on the pressure reading will be displayed.

Display with pressure reading and icons

Display elements
DVR 3pro

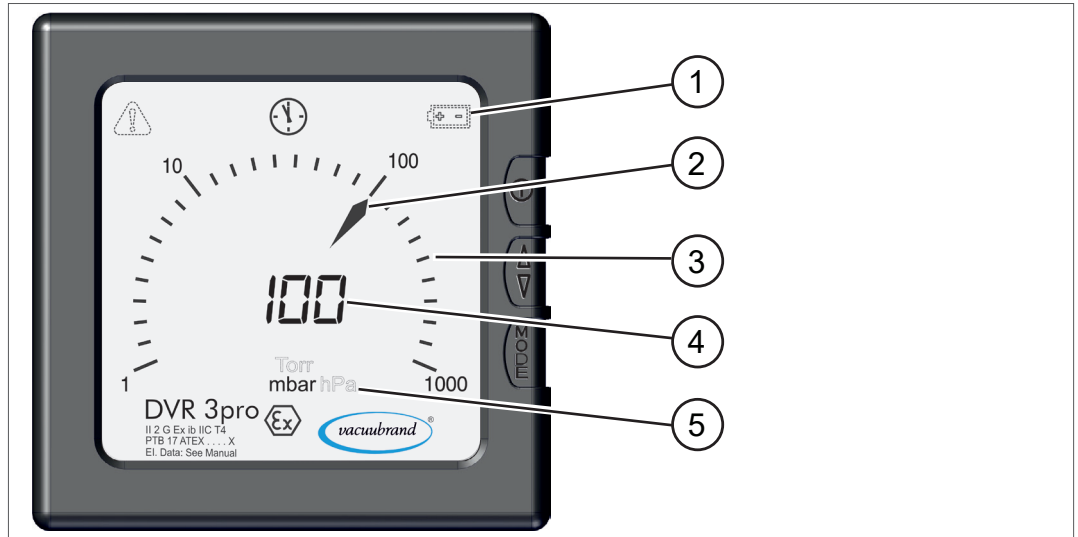









- 1 Display icons
- 2 Pointer (clock-hand)
- 3 Analog pressure reading, display scale with current pressure
- 4 Digital pressure reading, current pressure as numeral value
- 5 Pressure unit referring to pre-setting (mbar, Torr, hPa)

5.1.5 Display icons

With switched-on gauge additional symbols appear on the display, depending on state.

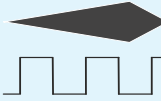
Meaning of display icons

Display icons
DVR 3pro

Icon	Meaning
	<p>Warning triangle</p> <ul style="list-style-type: none"> ▶ Warning ▶ Adjustment mode active
	<p>Clock</p> <ul style="list-style-type: none"> ▶ Automatic switch-off activated ▶ The display of the gauge switches off after approx. 30 Seconds ⇒ to stop switch-off press any key shortly
	<p>Battery</p> <ul style="list-style-type: none"> ▶ Battery low ▶ Battery replacement required
	<p>Pointer</p> <ul style="list-style-type: none"> ▶ Display measurement value ▶ Display pointer direction (left/right) ▶  = automatic adaptation of the measuring cycle; more frequent readings for large pressure variation
	<p>Pointer – Adjust measuring cycle</p> <ul style="list-style-type: none"> ▶  = 1x measuring per 3 Seconds = blinking cycle 3 Sec. ▶  = 1x measuring per 1 Second = blinking cycle 1 Sec. ▶  = 3x measuring per 1 Second = blinking cycle 0.3 Sec.

5.2 DVR 3pro handling

5.2.1 Select pressure unit

Set pressure unit

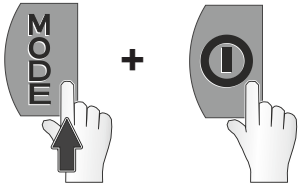

1. Press and hold the *MODE* key at the switched-off gauge and then press *ON/OFF* key.



- Displays the selected pressure unit, e. g., hPa.



2. Press key *UP/DOWN* as often as the required pressure unit is displayed.
 - Switchable: mbar, Torr, hPa



- Displays the selected pressure unit, e. g., mbar.



3. Press key *ON/OFF* to confirm the selection.



- Switch to pressure reading.
- Pressure unit adjusted on **mbar** .

5.2.2 Adjust switch on time and measuring cycle

Adjust power-on time

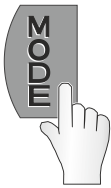

1. Switch on the gauge and press **MODE** key.



- ✓ On the display: Adjust power-on time.
- ✓ Display of the new pre-set power-on time, e. g., 5 Minutes (= delivery state).



2. Press the **UP/DOWN** key repeatedly or hold it until the required power-on time is displayed, e. g., 20 Minutes.

- Power-on time min. 1 – 600 Minutes; **On** = permanent ON
- Changing pointer direction with **MODE** key
 = decrease value /  = increase value



- ✓ Display of the new pre-set power-on time.
- ✓ This setting switches off the gauge automatically after 20 minutes.



3. Press key **ON/OFF** to confirm the adjustment.



- ✓ On the display: Pre-select measuring cycle.

Adjust measuring cycle



4. Press **UP/DOWN** key repeatedly until the required measuring cycle is displayed, e. g., **⌈ 3**.

- Selection **⌈ 1 – ⌈ 3; ⌈ R** (**⌈ R** = delivery state)

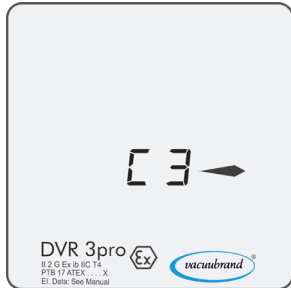

- ✓ Display of the new pre-set measuring cycle.
- ✓ 3x measuring per 1 Second = arrow with blinking cycle 0.3 Sec.



5. Press key **ON/OFF** to confirm the adjustment.



- ✓ Switch to pressure reading.

5.2.3 Pressure measurement

Switch-on vacuum measurement



1. Press **ON/OFF** key at the switched-off gauge.



- Display of actual pressure.

Switch-off vacuum measurement



1. Press and hold **ON/OFF** key shortly (approx. 1–2 Sec.) to switch off the gauge.



- Briefly displayed battery discharge status. Amount of pointers displays battery state,
- and indicates system data for our service department.



- Display switched off,

6 Cleaning and adjustment

6.1 Cleaning

Clean the sensor to remove malfunctions that are caused by a polluted sensor. We recommend to clean the sensor before adjustment.

IMPORTANT!

This chapter does not contain descriptions for the decontamination of the product. This chapter describes only simple cleaning and care measures.

6.1.1 Housing surface

Clean surface

Clean surface



⇒ Clean polluted surface with a clean, slightly wetted cloth. To moisten the cloth we recommend water or mild soap.

6.1.2 Sensor

Clean sensor

Clean sensor

1. Fill a small amount of solvent via flange into the gauge, e. g., cleaning solvent.
2. Let the solvent react for a few minutes.
3. Pour the solvent.
 - Dissolved substances or discolorations in the solvent are possible.
4. Repeat this procedure until no more pollutants are in the solvent.
5. Air the gauge until the internal chamber has dried.
6. Re-adjust the sensor.

6.2 Sensor adjustment, in general

The gauge is intended for continuous operation.

Adjustment is not part of the everyday operation. Perform adjustment only when the measured values differ from reference normal or when irregularities in pressure reading emerge.

Mostly the adjustment under vacuum will do → see chapter **6.2.3 Adjustment under vacuum on page 36**

6.2.1 Adjustment at atmospheric pressure

For correct adjustment the exact atmospheric pressure at your location is important. Exact data are provided, for example, by the weather service or an airport in your area. A precise counter barometer if available also displays the current atmospheric pressure.

Sensor adjustment at atmospheric pressure

1. Remove gauge from vacuum port and make sure that atmospheric pressure is present.

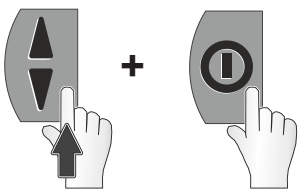

2. Press and hold the **UP/DOWN** key at the switched-off gauge and then press **ON/OFF**.



- Display adjustment mode - only active for approx. 20 seconds, as long as no further key is pressed.



3. Press the **UP/DOWN** key repeatedly or hold it until the current atmospheric pressure is displayed, e. g., 1005 mbar.

- Adjustment range 700–1060 mbar (525–795 Torr)
- Changing pointer direction with **MODE** key
 ◀ = decrease value / ▶ = increase value



- Value corresponds to current atmospheric pressure.



4. Press key **ON/OFF** to confirm the value.



- Switch to pressure reading.
- Display atmospheric pressure.
- Sensor adjusted to atmospheric pressure.

6.2.2 Adjustment to reference pressure

IMPORTANT!

For adjustment, the vacuum gauge must be evacuated to a precisely known reference pressure.

⇒ Check the accuracy of the ultimate vacuum with a calibrated reference vacuum gauge.

⇒ A faulty reference pressure measurement is transmitted directly to the gauge.

Sensor adjustment at reference pressure

1. Connect the gauge to a vacuum pump which pumps to a precise vacuum, e. g., down to 2 mbar.

2. Press and hold the **UP/DOWN** key at the switched-off gauge and then press **ON/OFF**.

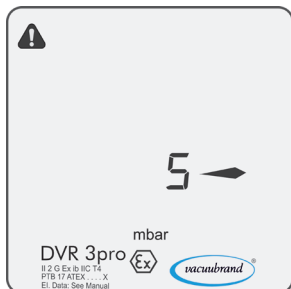
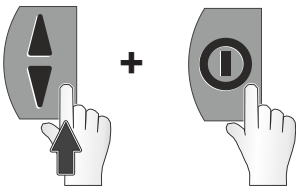

- ✓ Display adjustment mode - only active for approx. 20 seconds.
Display only at vacuum less than < 20 mbar (15 Torr).



3. Press key **UP/DOWN** as often as the required pressure unit is displayed, e. g., 2 mbar.

- Adjustment range 0–20 mbar (0–15 Torr)
- Changing pointer direction with **MODE key**
 = decrease value / = increase value

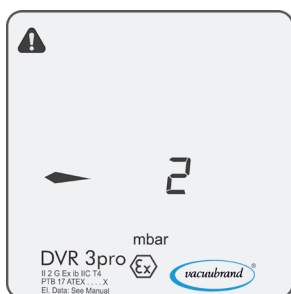

- ✓ Value corresponds to current reference pressure.



4. Press key **ON/OFF** to confirm the value.



- Switch to pressure reading.
- Display of current pressure.
- Sensor adjusted to reference pressure.



The adjustment to a reference pressure is an alternative method, if present vacuum pumps are not capable of providing an adequate vacuum (<1 mbar).

6.2.3 Adjustment under vacuum

NOTICE

The adjustment at vacuum always occurs to the final measured value with 0 mbar.

- ⇒ Pump down to an ultimate vacuum as low as possible.
- ⇒ Check the accuracy of the ultimate vacuum with a calibrated reference vacuum gauge.

Adjustment under vacuum

1. Connect the gauge to a vacuum pump which pumps to a precise vacuum, e. g., a rotary vane pump down to < 0,5 mbar.
2. Press and hold the **UP/DOWN** key at the switched-off gauge and then press **ON/OFF**.

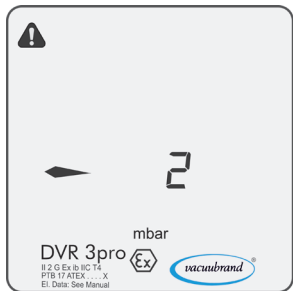
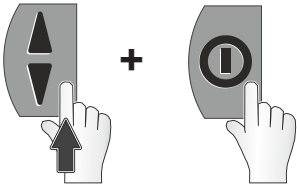

- ☑ Display adjustment mode - only active for approx. 20 seconds.
Display only at vacuum less than < 20 mbar (15 Torr).

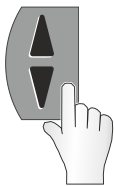

3. Press key **UP/DOWN** repeatedly until 0 mbar is displayed.

- Changing pointer direction with **MODE key**

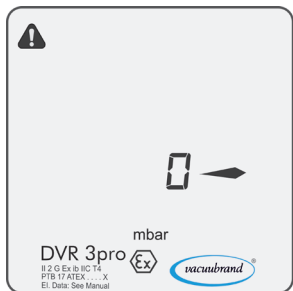

- ☑ Value for vacuum < 0,5 mbar.



4. Press key **ON/OFF** to confirm the value.

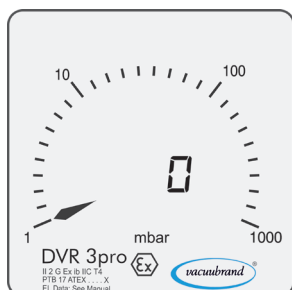

- Switch to pressure reading.
- Display of current pressure.
- Sensor adjusted under vacuum.

7 Resolving problems

	CAUTION
	<p>Malfunction because of incorrect repair by the customer.</p> <p>The gauge is not intended for the repair by customer.</p> <ul style="list-style-type: none"> ⇒ Open the vacuum gauge only for battery replacement. ⇒ If the gauge is defective, please send it to our Service Department or your local supplier.

Technical support

Technical support ⇒ To identify errors and potential remedies, please refer to the troubleshooting table: *Fault – Cause – Remedy*

For technical help or in case of errors, please contact our [Service](#)¹ department.

7.1 Error display

In case of malfunction a warning triangle appears on the display.

Example error display

→ Example Error display

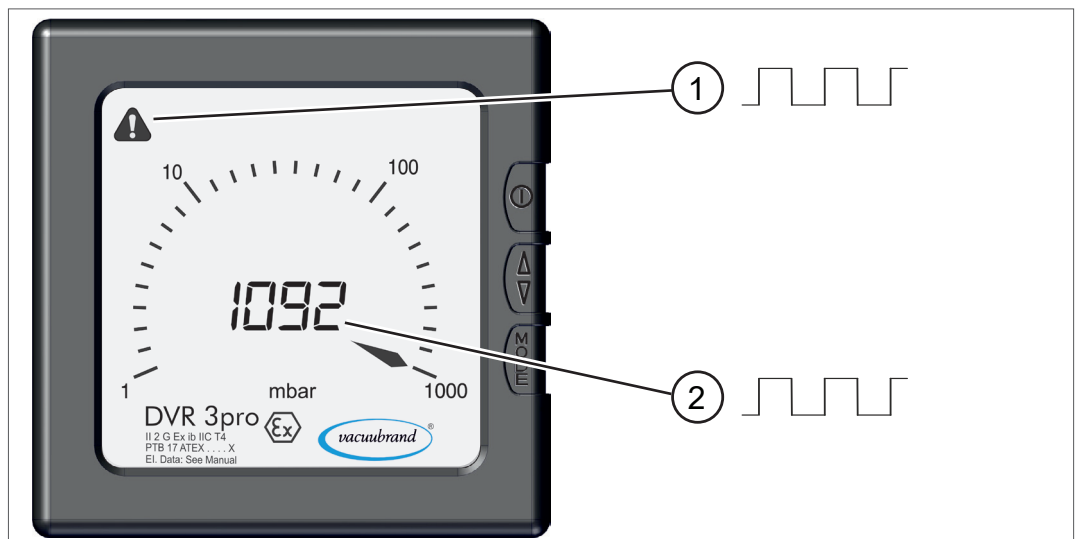

- 1 Warning triangle blinks
- 2 Measure display blinks
 - ▶ here: over pressure

1 -> Phone: +49 9342 808-5660, Fax: +49 9342 808-5555, service@vacuubrand.com

7.2 Fault – Cause – Remedy

Fault	Possible cause	Remedy
over pressure <i>Blinking cycle pressure reading and warning triangle</i>	<ul style="list-style-type: none"> ▶ Pressure too high. ▶ Measuring range exceeded. <p>⚠ WARNING! Risk of bursting. ⇒ Discharge the system immediately by <i>Venting</i>.</p>	<ul style="list-style-type: none"> ✓ Vent the system or apparatus. ✓ Reduce pressure. ✓ Perform sensor adjustment.
Under range <i>Blinking cycle pressure reading and warning triangle</i>	<ul style="list-style-type: none"> ▶ Measuring range fallen below. 	<ul style="list-style-type: none"> ✓ Pressure reading until 0 mbar (0 Torr). ✓ Perform sensor adjustment.
Front glass broken	<ul style="list-style-type: none"> ▶ Wrong cleaning agent used. ▶ Mechanically damaged. 	<ul style="list-style-type: none"> ✓ Send in gauge.
Wrong pressure readings displayed	<ul style="list-style-type: none"> ▶ Sensor measures incorrectly. ▶ Vacuum sensor polluted. ▶ Defective sensor. 	<ul style="list-style-type: none"> ✓ Clean sensor ✓ Perform sensor adjustment. ✓ Send in gauge.
Battery icon and/or display blinks	<ul style="list-style-type: none"> ▶ Battery low. 	<ul style="list-style-type: none"> ✓ Replace battery.
No display	<ul style="list-style-type: none"> ▶ Device switched off ▶ Power-on time elapsed. ▶ No voltage, battery empty or defective or wrong poled. 	<ul style="list-style-type: none"> ✓ Switch on device ✓ Extend power-on time. ✓ Check battery fastening. ✓ Replace battery.
Adjustment mode cannot be called-up <i>Blinking warning triangle, pressure reading = - - -</i>	<ul style="list-style-type: none"> ▶ A for sensor adjustment inadmissible pressure is reached (no adjustment possible in between pressure range 21 – 699 mbar). 	<ul style="list-style-type: none"> ✓ Perform adjustment at min. > 700 mbar atmospheric pressure or vacuum < 20 mbar. ✓ For adjustment connect a vacuum pump with precise vacuum and then move pump down to the possible pressure range.
Display of all LCD icons or no display despite of battery replacement.	<ul style="list-style-type: none"> ▶ Defective sensor. ▶ Defective measuring equipment 	<ul style="list-style-type: none"> ✓ Send in gauge.

8 Appendix

8.1 Technical information

Type	
Absolute pressure gauge – <i>rough vacuum</i>	DVR 3pro

8.1.1 Technical data

Technical data

Vacuum data	
DVR 3pro	
Measuring range, absolute	1060–1 mbar
Max. admissible pressure, absolute	1,5 bar
Temperature coefficient	< ±0.15 mbar (hPa)/K < ±0.11 Torr/K
Vacuum sensor (pressure transducer)	internal
ATEX conformity	II 2 G Ex ib IIC T4 Gb
internal volume	---
Resolution	1 mbar
Accuracy of measurement	< ±1 mbar/hPa/Torr, ±1 digit (after adjustment, constant temperature)
Measuring principle	Ceramic diaphragm (alumina), capacitive, gas type independent, absolute pressure
Measuring cycle (response time)	State of delivery ⓐ automatically; Selectable measuring cycle: ⓐ = 1x per 3s, ⓑ = 1x per 1s, ⓒ = 3x per 1s, ⓓ
Max. admissible media temperature (gas) non-explosive atmosphere:	
momentarily (< 5 Minutes)	80 °C
Continuous operation	40 °C
Ambient conditions	
Working temperature	10–40 °C
Storage and transport temperature	-10–60 °C
Altitude, max.	3000 m above sea level
Relative humidity	30–85 %, non condensing
Temperature compensation	---

Technical data

Connections	
Vacuum connection	Small flange KF DN 16
	Hose nozzle DN 6/10

Electrical data vacuum gauge	
Power supply	9 VDC
Alkaline battery	
Battery lifetime at	4000 h
Measuring cycle C2 , approx.	
Protection type	IP 40

Display	
Type	LC display (LCD)
Pressure reading	switchable: mbar, Torr, hPa
Automatic switch-off	State of delivery 5 minutes Power-on time selectable 1–600 Minutes or On = Continuous operation

Weight and dimensions		
Weight including Battery, approx.	350 g	
Dimensions	117 mm x 117 mm x 36 mm	
Measurement chamber inner volume (without hose nozzle)	4,23 cm ³	0.26 in ³

8.1.2 Wetted materials

Wetted materials

Component	Wetted materials
Vacuum sensor	Aluminium oxide ceramics, gold-coated
Sensor housing	PPS GF
Sealings	chemically resistant fluoroelastomer
Connection flange KF	PP GF 30
Hose nozzle	PP

8.1.3 Device data



- ⇒ In case of malfunction, please note type and serial number on the rating plate.
- ⇒ When contacting our service department, name us product type and serial number. With this information we can offer selective support and advice for your product.

Device data on rear side of the gauge

Rating plate data

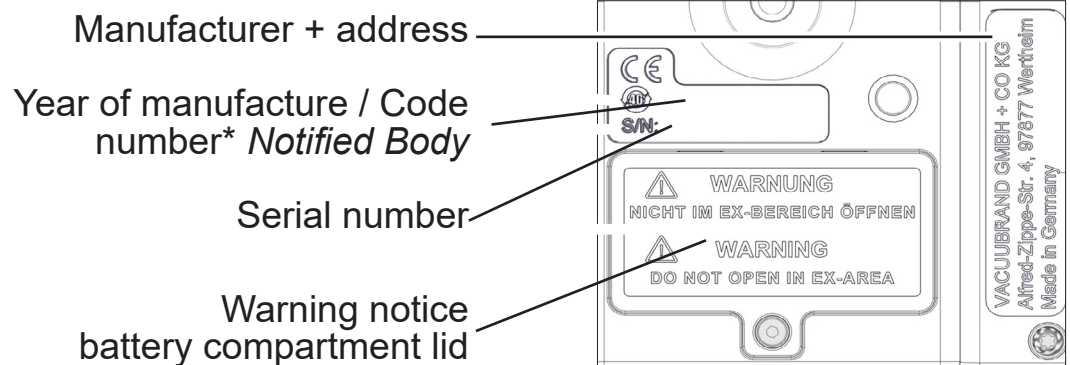

* Code number of **named body** for conformity assessment procedure

8.2 Ordering information

	Vacuum gauge	Order N°
	DVR 3pro	20682907
Ordering information accessories	Accessories	Order N°
	PTFE hose KF DN 16 (l = 1000 mm)	20686031
	Stainless steel tubing KF DN 16 (l = 1000 mm)	20673336
	Clamping ring KF DN 16	20660000
	Centering ring KF DN 16	20660124
	Hex key, size 2	20635062
	DAkKS calibration with first delivery	20900214
	DAkKS recalibration	20900215
Ordering information spare parts	Spare parts	Order N°
	Small flange KF 16 PP	20635110
	Protective cap DN 10/16	
	O-ring	
	Knurled nut M14x1 (union nut)	20637657
	Hose nozzle DN 6/10	20636635
	Locking ring for knurled nut	20637658
	9 V Block-type battery, type LR61, enclosed	20612891
	*approved types: Duracell Ultra Power MX 1604, Energizer 522, Varta Longlife extra 4122	
	Self-adhesive insulation PTFE-foil 23 x 15 mm (battery contact protection)	20635082
	Instructions for use	20901134

IMPORTANT!

* If any other battery type is used, the EX-approval for the gauge will be no longer valid.

Source of supply

International sales offices and specialized trade

Purchase original accessories and spare parts from your specialized distributor or through international sales offices of **VACUUBRAND GMBH + CO KG**.



- ⇒ Information about the complete product range are available in the current [product catalog](#).
- ⇒ For orders, questions about vacuum control and optimal accessories, please contact your specialized distributor or an [international sales office](#) of **VACUUBRAND GMBH + CO KG**.

8.3 Service

Service offer and
service range

Take advantage of the comprehensive service range of
VACUUBRAND GMBH + CO KG.



Service in detail

- product guidance and practical solutions,
- fast delivery of spare parts and accessories,
- professional maintenance,
- immediate repairs processing,
- Service on the spot (on request),
- [Calibration](#) (DAkkS accredited),
- return, disposal.

⇒ Visit our website for further information:
www.vacuubrand.com.

Servicing handling

Meet the
terms of service

1. Contact your local supplier or our Service Department.
2. Request a RMA number for your order.
3. Remove the battery, clean the product thoroughly and if necessary decontaminate it professionally.
4. Please fill in this form [Health and Safety Clearance](#) completely.
5. Return your product including:
 - RMA-N°,
 - Repair- or service order,
 - Form Health and Safety Clearance,
 - short error description.

Return (reshipment)



- ⇒ Reduce downtime, speed up the service process. Please keep the required data and documents ready when contacting our Service Department.
- ▶ Your order can be quickly and easily processed.
 - ▶ Hazards can be excluded.
 - ▶ A short description or photos may help for error location.

8.4 Index

Index	A		L	
	Accessories	43	Limitation of use	18
	Action step	8	M	
	approved battery types	43	Mandatory sign	7
	Approved block-type battery	43	Measuring cycle	26, 29
	ATEX specification	15	O	
	Atmospheric pressure	33	Operating elements	23
	B		Operating elements DVR 3pro	23
	Block-type battery (battery list)	43	Ordering information	43
	C		P	
	captive screw	16	Personnel (staff)	12
	Cleaning	31	Presentation convention operating steps	8
	Clean sensor	31	Prohibition symbol	7
	Clean surface	31	R	
	Connection options	20	Rating plate	42
	Contact	5	Rating plate data	42
	Copyright ©	6	Rear view	16
	Correct battery handling	13	Replace battery	19
	D		Resolving problems	38
	Delivery state automatic switch-off	28	Return (reshipment)	44
	Device data	42	S	
	Device name	15	Safety	5
	Display battery discharge state	30	Safety Information for Vacuum Equipment	10
	Display elements DVR 3pro	25	Safety instructions	10
	Display icons DVR 3pro	26	Safety precautions	12
	Disposal	13	Sales offices	43
	E		Sensor	40
	Error display	38	Service range	44
	Examples of use:	17	Servicing handling	44
	F		Side view	15
	Fault – Cause – Remedy	39	Signals	8
	Foreseeable misuse	11	Source of supply	43
	Front and rear side	15	Spare parts	43
	G		Symbols	7
	Gauge description	15	T	
	Goods arrival	14	Technical data	40, 41
	H		Technical information	40
	Handling instruction	8	Technical support	38
	Health and Safety Clearance	44	U	
	I		User information	5
	Icons	7	V	
	Improper use	10, 11	Vacuum connection	20
	Included materials	14	Vacuum sensor	40
	Insert battery	19	W	
	Installation	18	Warning levels	6
	Installation conditions	18	Warning symbol	7
	Intended use	10	Wetted materials	41
	J			
	Jump-back times	24		
	K			
	Key combination	24		
	Key function	23		

8.5 EC Declaration of Conformity

EG-Konformitätserklärung EC Declaration of Conformity Déclaration CE de conformité



Hersteller / Manufacturer / Fabricant:

VACUUBRAND GMBH + CO KG · Alfred-Zippe-Str. 4 · 97877 Wertheim · Germany

Hiermit erklärt der Hersteller, dass das Gerät konform ist mit den Bestimmungen der Richtlinien:

Hereby the manufacturer declares that the device is in conformity with the directives:

Par la présente, le fabricant déclare, que le dispositif est conforme aux directives:

- 2014/30/EU
- 2014/34/EU
- 2011/65/EU, 2015/863

Baumusterprüfbescheinigung / Type examination certificate / Attestation d'examen de type:

PTB 19 ATEX 2004 X

Vakuummessgerät / Vacuum gauge / Vacuomètre

Typ / Type / Type: **DVR 3pro**

Artikelnummer / Order number / Numéro d'article: 20682907

Seriennummer / Serial number / Numéro de série: Siehe Typenschild / See rating plate / Voir plaque signalétique

Angewandte harmonisierte Normen / Harmonized standards applied / Normes harmonisées utilisées:

EN ISO 12100:2010 (ISO 12100:2010), EN 61010-1:2010 + A1:2019 + A1:2019/AC:2019,
IEC 61010-1:2010 + COR:2011 + A1:2016, modifiziert / modified / modifié + A1:2016/COR1:2019,
EN 61326-1:2013 (IEC 61326-1:2012),
EN IEC 60079-0:2018 (IEC 60079-0:2017), EN 60079-11:2012 (IEC 60079-11:2011 + COR:2012),
EN IEC 63000:2018 (IEC 63000:2016)

Bevollmächtigter für die Zusammenstellung der technischen Unterlagen / Person authorised to compile the technical file / Personne autorisée à constituer le dossier technique:

Dr. Constantin Schöler · VACUUBRAND GMBH + CO KG · Germany

Ort, Datum / place, date / lieu, date: Wertheim, 05.10.2023

(Dr. Constantin Schöler)

Geschäftsführer / Managing Director / Gérant

ppa.

(Jens Kaibel)

*Technischer Leiter / Technical Director /
Directeur technique*

VACUUBRAND GMBH + CO KG

Alfred-Zippe-Str. 4
97877 Wertheim

Tel.: +49 9342 808-0

Fax: +49 9342 808-5555

E-Mail: info@vacuubrand.com

Web: www.vacuubrand.com

VACUUBRAND®

8.6 Declaration of Conformity – China RoHS 2

VACUUBRAND GMBH + CO KG has made reasonable efforts to ensure that hazardous materials and substances may not be used in its products.

In order to determine the concentration of hazardous substances in all homogeneous materials of the subassemblies, a “Product Conformity Assessment” (PCA) procedure was performed. As defined in GB/T 26572 the “Maximum Concentration Value” limits (MCV) apply to these restricted substances:

- Lead (Pb): 0.1%
- Mercury (Hg): 0.1%
- Cadmium (Cd): 0.01%
- Hexavalent chromium (Cr(+VI)): 0.1%
- Polybrominated biphenyls (PBB): 0.1%
- Polybrominated diphenyl ether (PBDE): 0.1%

Environmentally Friendly Use Period (EFUP)

EFUP defines the period in years during which the hazardous substances contained in electrical and electronic products will not leak or mutate under normal operating conditions. During normal use by the user such electrical and electronic products will not result in serious environmental pollution, cause serious bodily injury or damage to the user's assets.

The Environmentally Friendly Use Period for VACUUBRAND products is 40 years.



此表格是按照SJ/T 11364-2014中规定所制定的。

This table is created according to SJ/T 11364-2014.

MATERIAL CONTENT DECLARATION FOR VACUUBRAND PRODUCTS							
部件名称 Part name	有毒有害物质或元素 Hazardous substances						环保期限标识 EFUP
	铅 Pb	汞 Hg	镉 Cd	六价铬 Cr(+VI)	多溴联苯 PBB	多溴二苯醚 PBDE	
包装 Packaging	○	○	○	○	○	○	
塑料外壳 / 组件 Plastic housing / parts	○	○	○	○	○	○	
真空油 Vacuum oil	○	○	○	○	○	○	
电池 Battery	○	○	○	○	○	○	
玻璃 Glass	X	○	○	○	○	○	
电子电气组件 Electrical and electronic parts	X	○	○	○	○	○	
控制器 / 测量设备 Controller / measuring device	X	○	○	○	○	○	
金属外壳 / 组件 Metal housing / parts	X	○	○	○	○	○	
电机 Motor	X	○	○	○	○	○	
配件 Accessories	X	○	○	○	○	○	

注释: 此表格适用于所有产品。以上列出的元件或组件不一定都属于所附产品的组成。

Note: Table applies to all products. Some of the components or parts listed above may not be part of the enclosed product.

O: 表示该有毒有害物质在该部件所有均质材料中的含量均在GB/T 26572规定的限量要求以下。

O: Indicates that the above mentioned hazardous substance contained in all homogeneous materials of the part is below the required limit as defined in GB/T 26572.

X: 表示该有毒有害物质至少在该部件某一均质材料中的含量超出GB/T 26572规定的限量要求。

X: Indicates that the above mentioned hazardous substance contained in at least one of the homogeneous materials of this part is above the required limit as defined in GB/T 26572.

除上表所示信息外，还需声明的是，这些部件并非是有意图用铅（Pb）、汞（Hg）、铬（Cd）、六价铬（Cr(+VI)）、多溴联苯（PBB）或多溴二苯醚（PBDE）来制造的。

Apart from the disclosures in the above table, the subassemblies are not intentionally manufactured or formulated with lead (Pb), mercury (Hg), cadmium (Cd), hexavalent chromium (Cr+VI), polybrominated biphenyls (PBB), and polybrominated diphenyl ethers (PBDE).

Products manufactured by VACUUBRAND may enter into further devices (e.g., rotary evaporator) or can be used together with other appliances (e.g., usage as booster pumps).

With these products and appliances in particular, please note the EFUP labeled on these products. VACUUBRAND will not take responsibility for the EFUP of those products and appliances.

Place, date: Wertheim, 06/04/2020



(Dr. F. Gitmans)
Managing Director

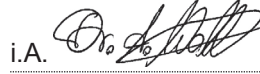

i.A. (Dr. A. Wollschläger)
Regulatory Affairs Manager

VACUUBRAND GMBH + CO KG
Alfred-Zippe-Str. 4
97877 Wertheim
Germany

Tel.: +49 9342 808-0
Fax: +49 9342 808-5555
E-Mail: info@vacuubrand.com
Web: www.vacuubrand.com

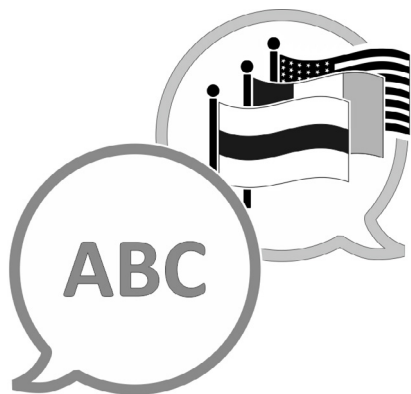
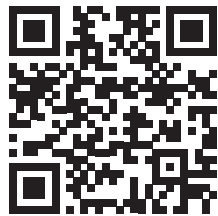

[VACUUBRAND > Support > Manuals](#)

Manufacturer:

VACUUBRAND GMBH + CO KG
Alfred-Zippe-Str. 4
97877 Wertheim
GERMANY

Phone:

Head office +49 9342 808-0
Sales +49 9342 808-5550
Service +49 9342 808-5660

Fax: +49 9342 808-5555

Email: info@vacuubrand.com

Web: www.vacuubrand.com